

GAMME STANDARD

Distributeurs commande pneumatique |

Pneumatically piloted valves



INFORMATIONS GÉNÉRALES GENERAL INFORMATION

- Distributeurs 3/2 - 5/2 - 5/3 avec raccordements G1/8" - G1/4" - G3/8" - G1/2"
3/2 - 5/2 - 5/3 spool valves with G1/8" - G1/4" - G3/8" G1/2", threaded ports
- Montage en ligne, sur embases multiples ou monobloc
(Voir embases p.136 à 141)
Installation in-line, gang or manifold mounted
- Large gamme de pilotages
Comprehensive range of actuations
- Versions avec fonctions logiques intégrées
Versions with integrated logic element
- Distributeurs spéciaux sur demande
Special versions on request

Matériaux

Corps : Aluminium anodisé
Ressort : Inox
Joints : NBR
Tiroir : Aluminium nickelé
Parties internes : Laiton OT58

Materials

Body : Aluminium 11S
Springs : Stainless steel
Seals : NBR
Spool : Nickel plated aluminium
Internal parts : Brass OT58

Débit nominal à 6 bar

G1/8" : 550 NL/min G1/4" : 1100 NL/min
G3/8" : 2250 NL/min G1/2" : 4600 NL/min

Débit (NL/min) - G1/8" flow rates

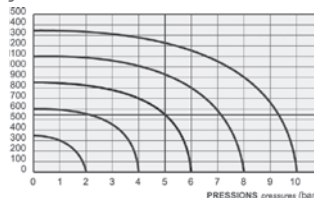

Débit (NL/min) - G1/4" flow rates

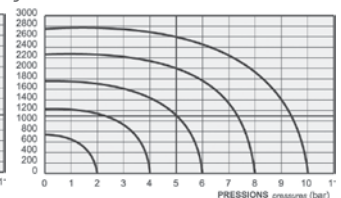

	G1/8"	G1/4"	G1/2"
Monostable <i>Monostable</i>	TRA (14) : 6 ms TRR (12) : 15 ms	TRA (14) : 7 ms TRR (12) : 15 ms	TRA (14) : 4 ms TRR (12) : 8 ms
Bistable <i>Bistable</i>	TRA (14) : 7 ms TRR (12) : 7 ms	TRA (14) : 7 ms TRR (12) : 7 ms	TRA (14) : 4 ms TRR (12) : 4 ms

Diamètre nominal <i>Nominal orifice</i>	G1/8" : 5 mm - G1/4" : 7.5 mm G3/8" : 10mm - G1/2" : 13mm	
Température de travail <i>Temperature range</i>	max +60°C	
Pression de travail <i>Working pressure</i>	max 10 bar max 1 MPa	
Pression de commande <i>Actuating pressure</i>	monostable [<i>monostable</i>]	bistable [<i>bistable</i>]
	2.5 ... 10 bar 0.25 ... 1 MPa	1 ... 10 bar 0.1 ... 1 MPa
Fluide <i>Fluid</i>	air filtré 50µ avec ou sans lubrification 50µ filtered lubricated or non lubricated air	

GAMME STANDARD

Distributeurs commande pneumatique G1/4" |

Pneumatically piloted valves

322 MC

Distributeur 3/2 NF monostable
commande pneumatique
rappel à combinaison de ressort
raccordement G1/4"

*3/2 NC pneumatic pilot
spring return - G1/4"*

Version Atex 2GD T6 : 322MC.ATEX

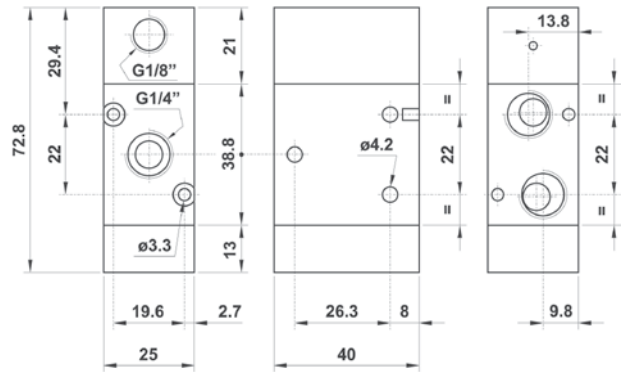
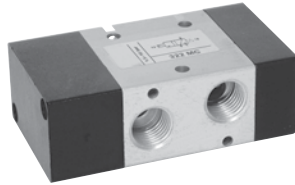
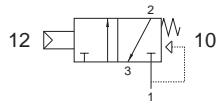

322 MCA

Distributeur 3/2 NO monostable
commande pneumatique
rappel à combinaison de ressort
raccordement G1/4"

*3/2 NO pneumatic pilot
spring return - G1/4"*

Version Atex 2GD T6 : 322MCA.ATEX

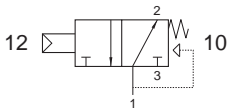

322 MCS

Distributeur 3/2 NF monostable
commande pneumatique 0,6 bar
rappel à combinaison de ressort
raccordement G1/4"

*3/2 NC pneumatic pilot 0.6 bar
spring return - G1/4"*

Version Atex 2GD T6 : 322MCS.ATEX

Pression de travail : min. 2.5 bar (0.25 MPa)
Pression de commande : min. 0.6 bar (0.06 MPa)
*Work pressure : min. 2.5 bar (0.25 MPa)
Pilot pressure : min. 0.6 bar (0.06 MPa)*

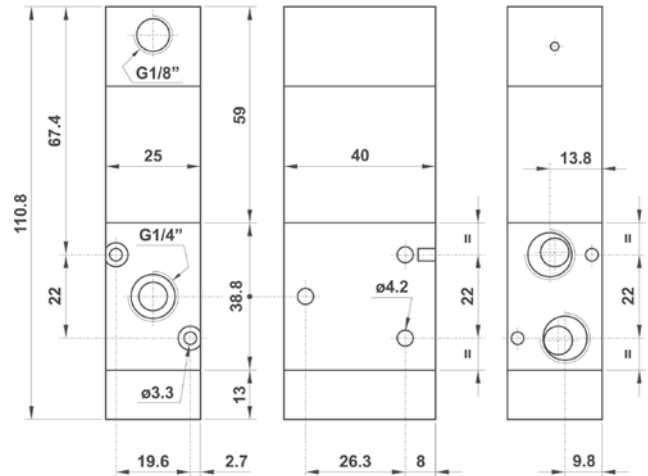
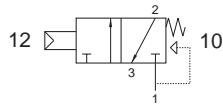

522 MC

Distributeur 5/2 monostable
commande pneumatique
rappel à combinaison de ressort
raccordement G1/4"

*5/2 pneumatic pilot
spring return - G1/4"*

Version Atex 2GD T6 : 522MC.ATEX

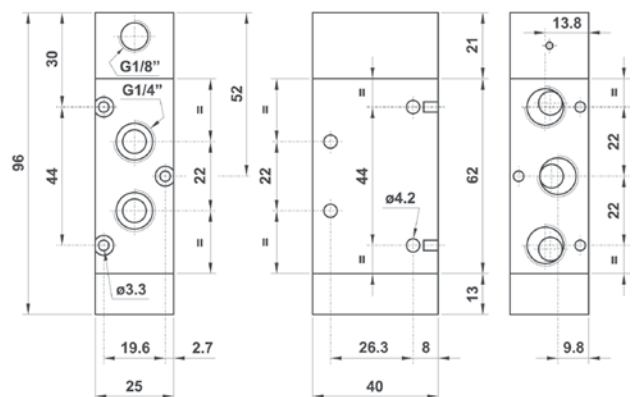
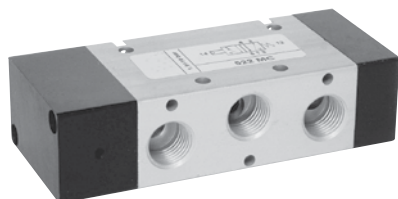
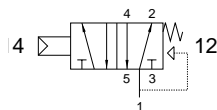

GAMME STANDARD

Distributeurs commande pneumatique G1/4" |

Pneumatically piloted valves

522 MCS

Distributeur 5/2 monostable
commande pneumatique 0,6 bar
rappel à combinaison de ressort
raccordement G1/4"

5/2 pneumatic pilot 0.6 bar
spring return - G1/4"

Version Atex 2GD T6 : 522MCS.ATEX

Pression de travail : min. 2.5 bar (0.25 MPa)

Pression de commande : min. 0.6 bar (0.06 MPa)

Work pressure : min. 2.5 bar (0.25 MPa)

Pilot pressure : min. 0.6 bar (0.06 MPa)

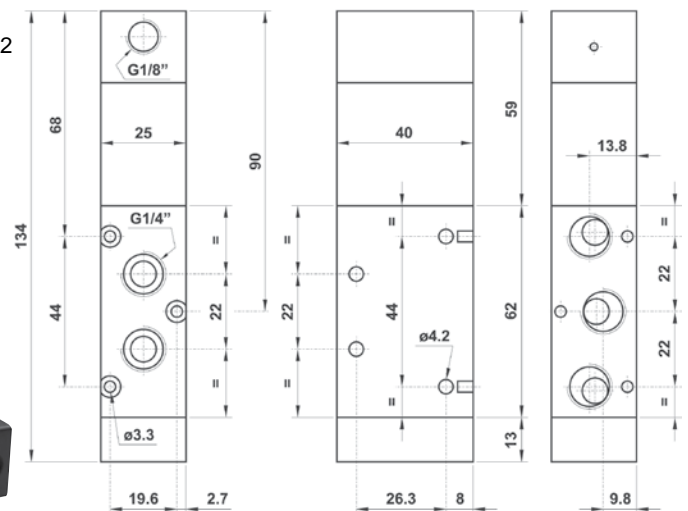
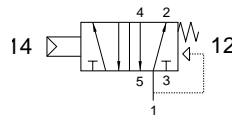
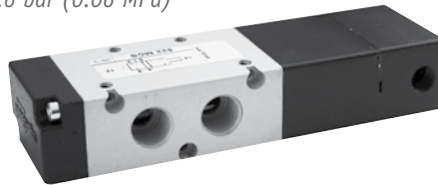

322 MC SUP

Distributeur 3/2 NF monostable
commande pneumatique
rappel à combinaison de ressort
raccordement G1/4"

(pilotage pneumatique en bout)
3/2 NC pneumatic pilot on the top
spring return - G1/4"

Version Atex 2GD T6 : 322MCSUP.ATEX

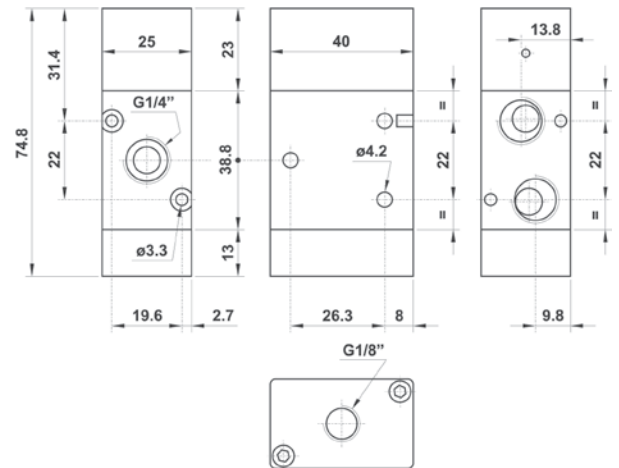
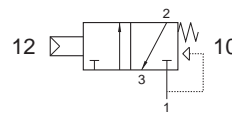
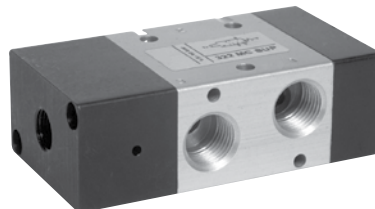

522 MC SUP

Distributeur 5/2 monostable
commande pneumatique
rappel à combinaison de ressort
raccordement G1/4"

(pilotage pneumatique en bout)
5/2 pneumatic pilot on the top
spring return - G1/4"

Version Atex 2GD T6 : 522MCSUP.ATEX

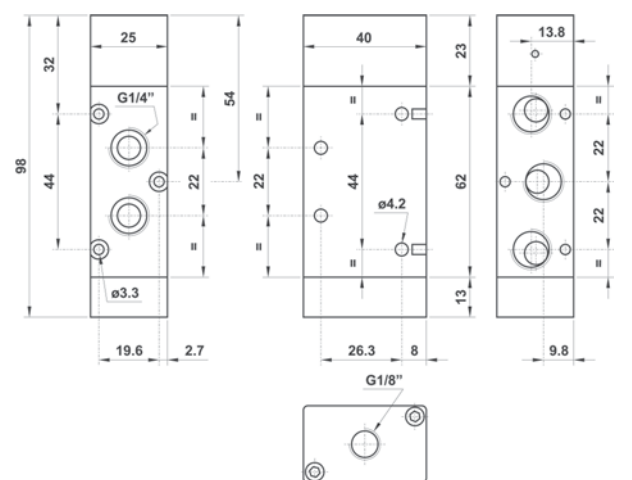
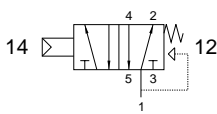
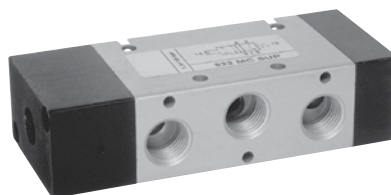

GAMME STANDARD

Distributeurs commande pneumatique G1/4" |

Pneumatically piloted valves

322 CC

Distributeur 3/2 bistable
commande pneumatique
raccordement G1/4"

3/2 double pneumatic pilot - G1/4"

Version Atex 2GD T6 : 322CC.ATEX

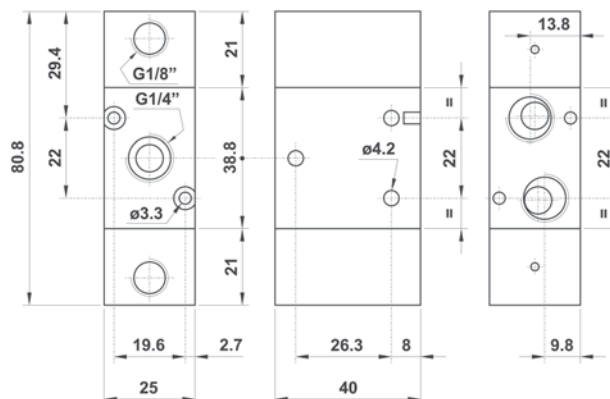
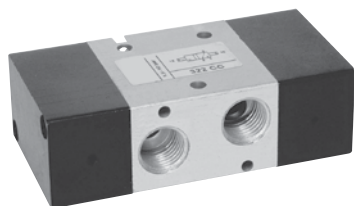
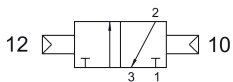

322 CCD

Distributeur 3/2 bistable différentiel
raccordement G1/4"

*3/2 double pneumatic pilot
with differential - G1/4"*

Version Atex 2GD T6 : 322CCD.ATEX

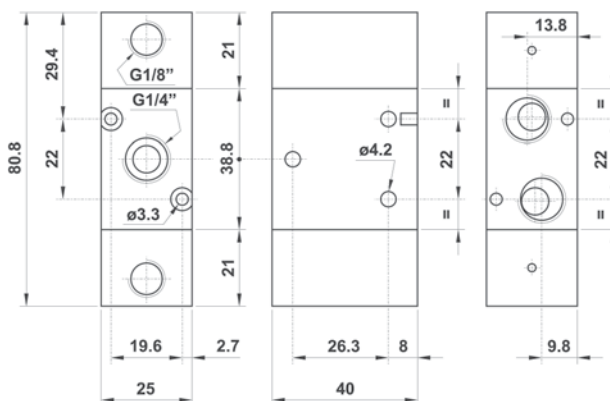
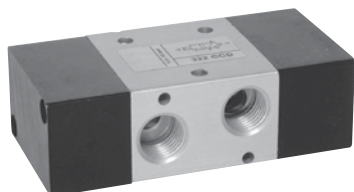
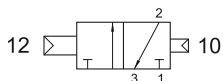

GAMME STANDARD

Distributeurs commande pneumatique G1/4" |

Pneumatically piloted valves

322 CFP

Distributeur 3/2 NF monostable
commande pneumatique
rappel ressort pneumatique
raccordement G1/4"
3/2 NC pneumatic pilot
pneumatic spring return - G1/4"

Version Atex 2GD T6 : 322CFP.ATEX

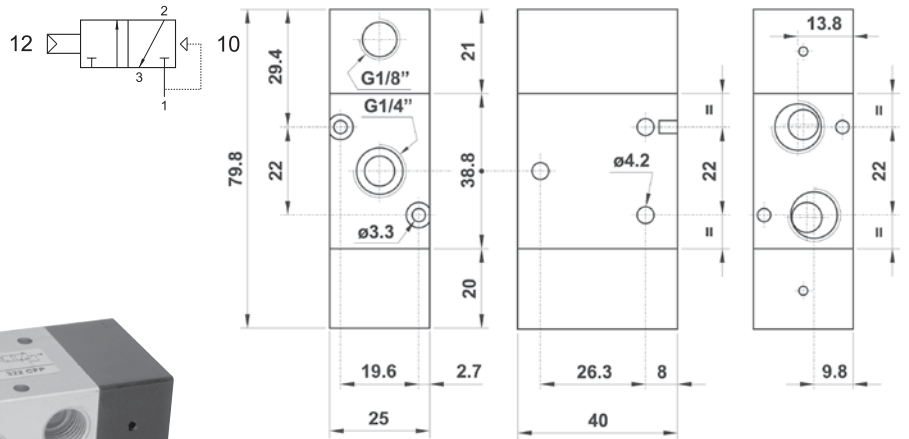
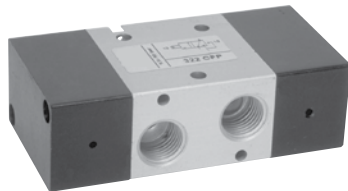

322 CC SUP

Distributeur 3/2 bistable
commande pneumatique
raccordement G1/4"
(pilotages pneumatiques en bout)
3/2 double pneumatic pilot on the top - G1/4"

Version Atex 2GD T6 : 322CCSUP.ATEX

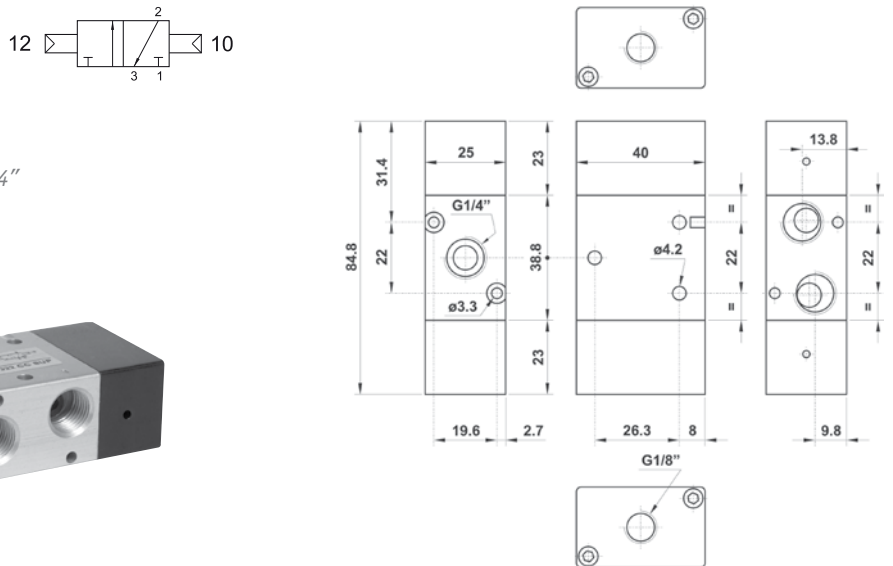
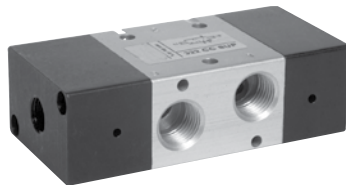

522 CC

Distributeur 5/2 bistable
commande pneumatique
raccordement G1/4"
5/2 double pneumatic pilot - G1/4"

Version Atex 2GD T6 : 522CC.ATEX

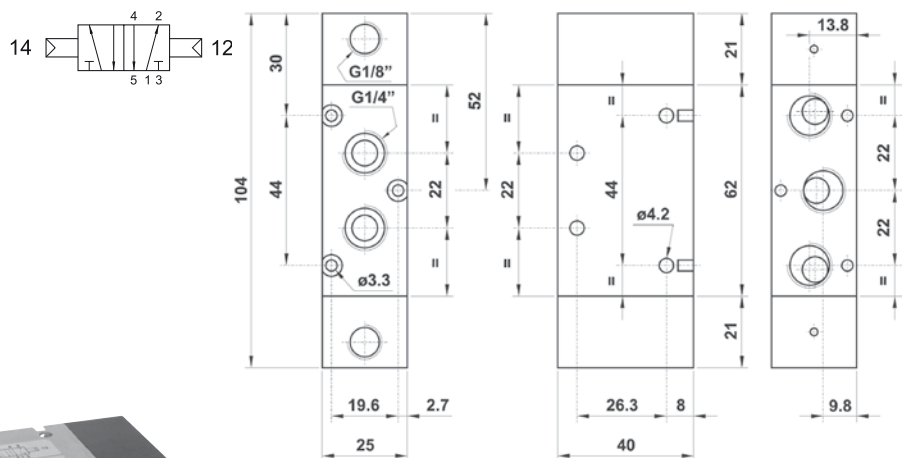
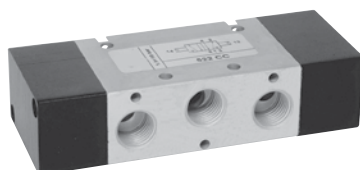

GAMME STANDARD

Distributeurs commande pneumatique G1/4" |

Pneumatically piloted valves

522 CCD

Distributeur 5/2 bistable différentiel
commande pneumatique
raccordement G1/4"

5/2 double pneumatic pilot with differential - G1/4"

Version Atex 2GD T6 : 522CCD.ATEX

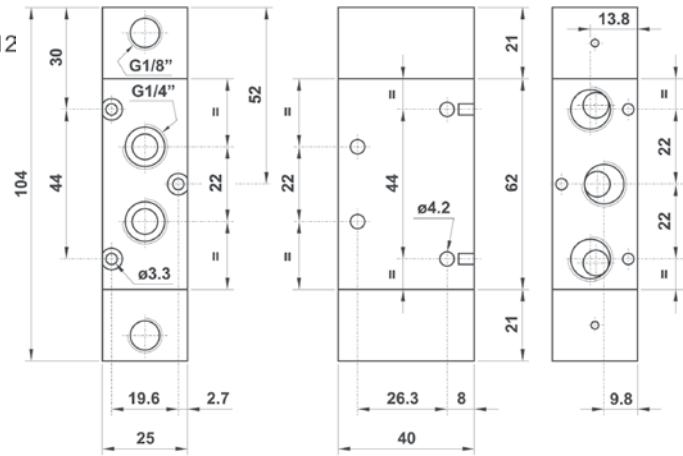
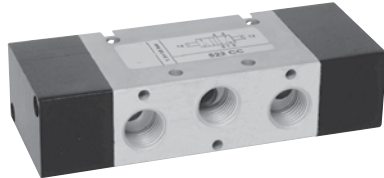
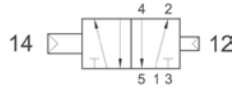

522 CFP

Distributeur 5/2 monostable
commande pneumatique
rappel ressort pneumatique
raccordement G1/4"

*5/2 pneumatic pilot
pneumatic spring return - G1/4"*

Version Atex 2GD T6 : 522CFP.ATEX

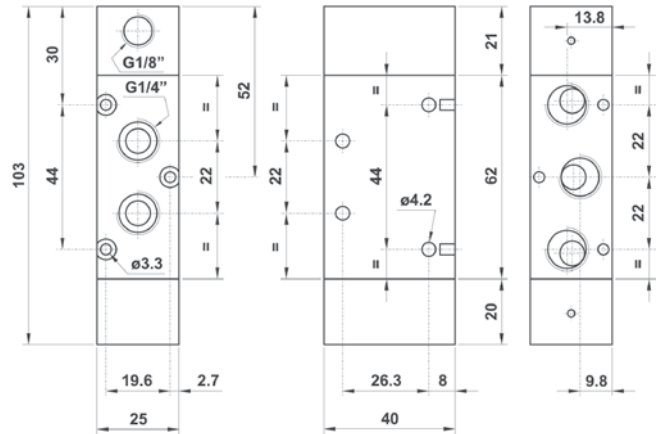
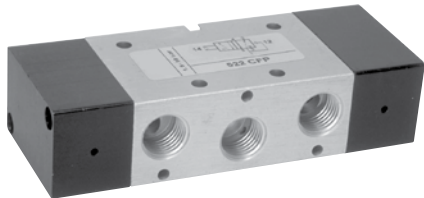
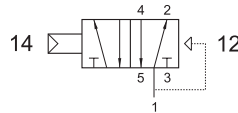

5223C CC

Centre fermé
Closed center

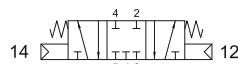

5223A CC

Centre ouvert
Open center

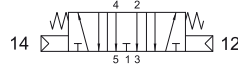

5223P CC

Centre en pression
Pressurized center

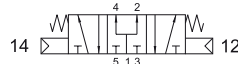

Distributeur 5/3
commande pneumatique
raccordement G1/4"

5/3 double pneumatic pilot - G1/4"

Version Atex 2GD T6 : 5223*CC.ATEX

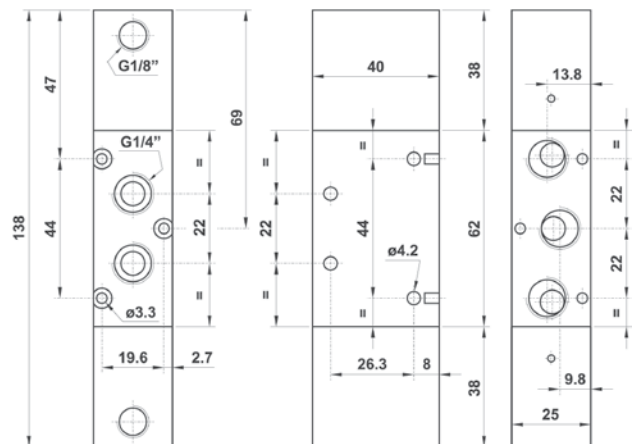

GAMME STANDARD

Distributeurs commande pneumatique G1/4" |

Pneumatically piloted valves

522 CC SUP

Distributeur 5/2 bistable
commande pneumatique
raccordement G1/4"
(pilotages pneumatiques en bout)
5/2 double pneumatic pilot on the top - G1/4"

Version Atex 2GD T6 : 522CCSUP.ATEX

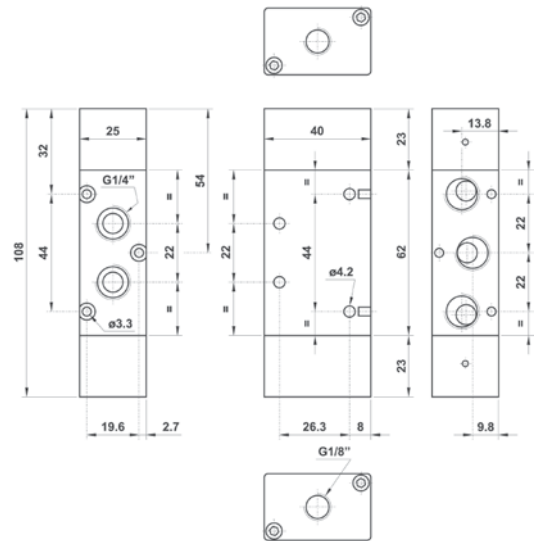
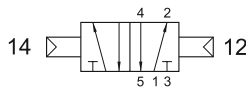
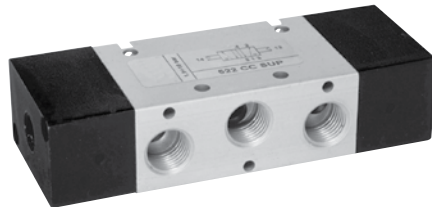

322 ORM

Distributeur 3/2 NF monostable
par cellule **OU** intégrée
rappel à combinaison de ressort
raccordement G1/4"

*3/2 NC pneumatic pilot with integrated OR element
spring return - G1/4"*

Version Atex 2GD T6 : 322ORM.ATEX

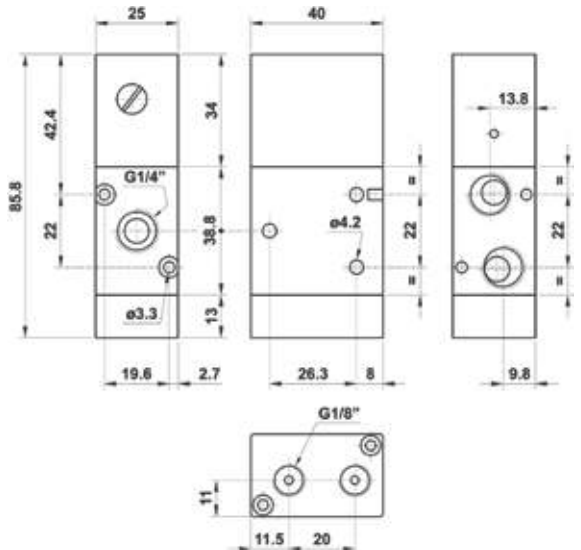
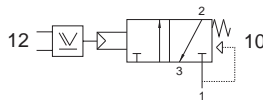

322 ANDM

Distributeur 3/2 NF monostable
par cellule **ET** intégrée
rappel à combinaison de ressort
raccordement G1/4"

3/2 NC pneumatic pilot with integrated AND element - spring return - G1/4"

Version Atex 2GD T6 : 322ANDM.ATEX

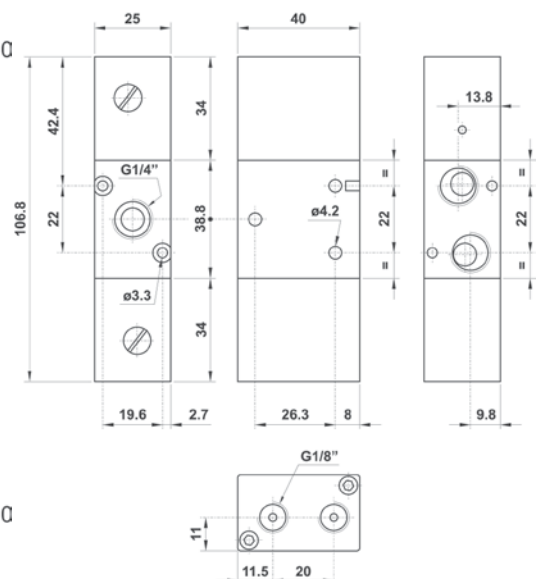
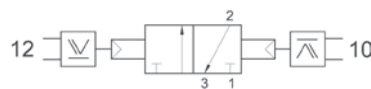
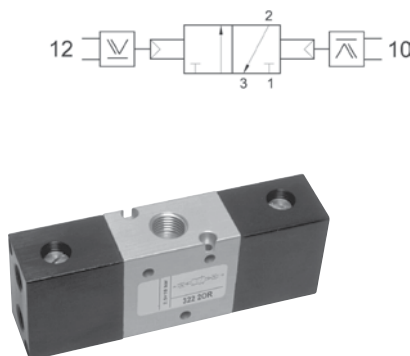
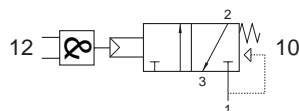

322 2AND

Distributeur 3/2 bistable
par cellules **ET** intégrées
raccordement G1/4"

*3/2 double pneumatic pilot
with integrated AND element - G1/4"*

Version Atex 2GD T6 : 3222AND.ATEX

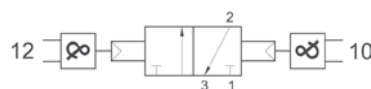

GAMME STANDARD

Distributeurs commande pneumatique G1/4" |

Pneumatically piloted valves

522 ORM

Distributeur 5/2 monostable
par cellule **OU** intégrée
bistable

raccordement G1/4"

5/2 pneumatic pilot with integrated **OR** element
spring return - G1/4"

Version Atex 2GD T6 : 522ORM.ATEX

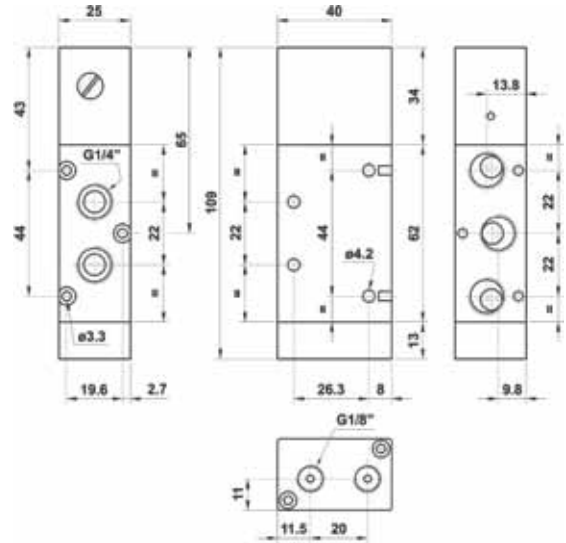
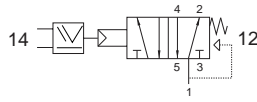

522 ANDM

Distributeur 5/2 monostable
par cellule **ET** intégrée
bistable

raccordement G1/4"

5/2 pneumatic pilot with integrated **AND** element
spring return - G1/4"

Version Atex 2GD T6 : 522ANDM.ATEX

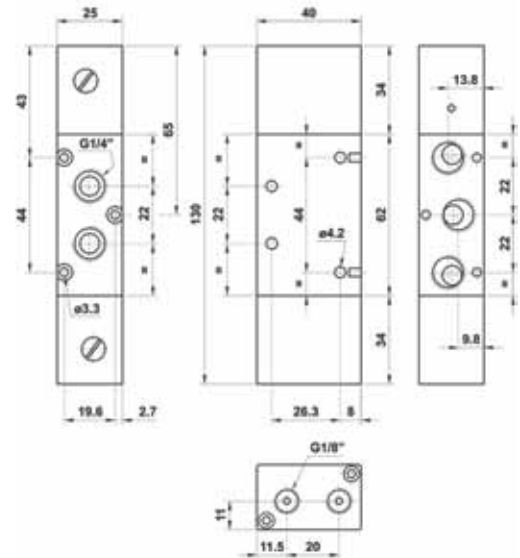
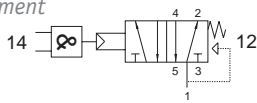

522 2OR

Distributeur 5/2 bistable
par cellules **OU** intégrées
raccordement G1/4"

5/2 double pneumatic pilot
with integrated **OR** element - G1/4"

Version Atex 2GD T6 : 5222OR.ATEX

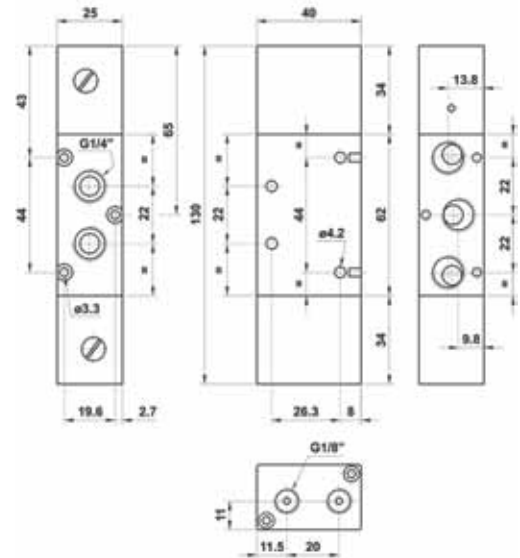
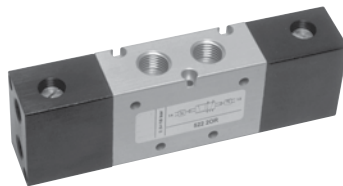

522 2AND

Distributeur 5/2 bistable
par cellules **ET** intégrées
raccordement G1/4"

5/2 double pneumatic pilot
with integrated **AND** element - G1/4"

Version Atex 2GD T6 : 5222AND.ATEX

